

Powers™ Controls

TH 192 DN Day-Night and TH 192 DNV Day-Night-Vent Room Thermostat

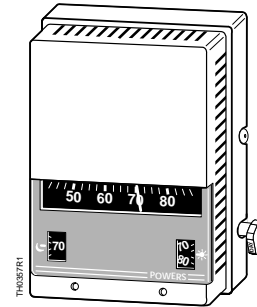

Description

The TH 192 DN & DNV thermostats are proportional single output, dual set point, 2-pipe or 3-pipe (high air capacity) sensor controllers. Each thermostat includes a wall mounting plate for installation in a variety of rough-in terminal boxes. Sensitive bimetals respond to temperature change to modulate control air through a flapper nozzle. Two set point dials are provided. When the supply air pressure changes from 18 to 25 psi (124 to 172 kPa), the thermostat automatically switches from the day to the night set point respectively. Air connections are made with 5/32" (4 mm) OD plastic tubing, directly to the thermostat chassis for retrofit applications or with plug-in adapters (provided with the TH 192 rough-in terminal box or optional accessories) which slide into the wall mounting plate.

Features

- Direct and reverse acting for day and night modes (DN models)
- Two separate adjustable temperature set point indicating dials
- Two highly sensitive bimetal thermostatic elements
- Operating mode automatically switches from day to night on change of main air supply pressure
- Manual override selector ensures off-hour occupancy comfort
- Single screw adjustment for changeover switch set point
- Individual field adjustable sensitivity with graduated scale for each mode
- Integral field adjustable limit stops
- Control pressure test port accessible without removing cover
- Easily replaceable thermometer, set point dials, filters, and restrictor plate
- Fahrenheit or Celsius set point dials
- Covers available for concealed or exposed thermometers and for either concealed, key, or exposed knob adjustment and set point adjustment
- Standard plastic thermostat covers provide desert beige or white finish

Optional Design Features

- Fixed temperature limit stops meet government specifications
- Metal covers available in standard configurations with a variety of finishes
- Competitor adapter mounting kits available
- All thermostat chassis available with optional 1/2" large set point adjustment knobs

Application

TH 192 DN & DNV thermostats provide day to night (or weekend) temperature setback to control pneumatic valve and damper actuators in heating and cooling applications (Figure 1) such as air conditioners, space heaters, unit ventilators, and air volume controllers.

The day-night thermostat is particularly useful in locations where all rooms in a zone are not vacated at the same time. Using time clocks on evenings and weekends to reset the control system to the night mode ensures optimum energy management. When a zone is operating in maximum economy mode at night, an occupant can reset an individual space to day temperature by switching a manual override. During night control, the TH 192 DNV provides a separate output signal (full air supply) which allows ventilation to occur.

TH 192 DN & DNV thermostats maintain maximum economy and occupant comfort automatically as a day progresses from the day time set point (65 to 68°F, 18 to 20°C) to the night time set point (55 to 60°F, 13 to 16°C). The thermostats are available with covers that conceal or expose the set point adjustment dials.

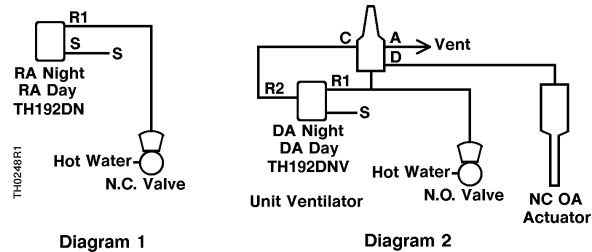

Figure 1. Typical TH 192 DN & DNV Thermostat Applications.

Table 1. Typical TH 192 DNV Thermostat Application.

Chassis Port R2 Pressure	Operation Mode (Air Supply)	Switching Relay Connection
0 Psig (0 kPa)	Day (S = 18 Psig, 124 kPa)	B - D
0 Psig (0 kPa)	Night Occupied	B - D
Full Air Supply	Night (S = 25 Psig, 172 kPa)	A - D

Piping

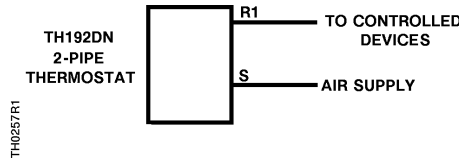

Figure 2. TH 192 DN Thermostat Connections.

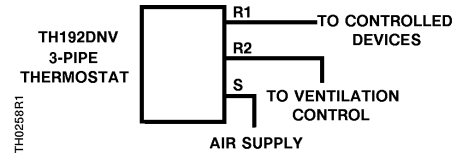

Figure 3. TH 192 DNV Thermostat Connections.

Product Numbers and Ordering Information

Chassis

See Table 2 for product number and ordering information on TH 192 DN & DNV thermostat chassis.

1. Is a Fahrenheit or Celsius scale required?
2. Is the day and night time control direct or reverse acting?
3. Is a separate, full supply output signal required for ventilation control?
4. Where is set point adjustment knob located?
 - a. Adjustment knob located at bottom of chassis.
 - b. Adjustment knob on front with 1/2" large exposed knob.

Table 2. TH 192 DN & DNV Thermostat Chassis Part Numbers.

Chassis with Wall Plate					
Connection Type	Control Action	Fahrenheit		Celsius	
		Exposed at Bottom of Cover	Exposed 1/2" Knob on Cover *	Exposed at Bottom of Cover	Exposed 1/2" Knob on Cover *
Two or Three Pipe Relay	Day and Night are Direct Acting	192-204	192-204K	192-224	192-224K
	Day and Night are Reverse Acting	192-205	192-205K	192-225	192-225K
	Day and Night are Direct Acting with Night Vent	192-206	192-206K	192-226	192-226K

* This feature requires a key set point adjustment cover (or key type cover). See Table 3.

Covers

See Table 3 for product number and ordering information on TH 192 DN & DNV thermostat covers.

1. Is the set point adjustment exposed for customer adjustment or concealed to prevent alteration of setting?
2. Is the thermometer exposed or concealed?
3. Is the set point indication exposed or concealed behind cover?
4. Is a plastic or zinc cast metal cover required?
 - a. Plastic covers order 192-2XX.
 - b. Metal covers order 192-3XX.
5. Is finish of cover standard or optional?
 - a. Standard cover is plastic, desert beige color.
 For white plastic cover option, add "W" suffix code to cover part number (e.g., 192-256W).
 - b. Optional covers are plastic or metal and available in a variety of colors per Table 3.

Table 3. TH 192 DN & DNV Thermostat Cover Part Numbers.

Set Point Adjustment	Cover Configuration		Cover Part Number (See Note 2)	
	Thermometer	Set Point Indicator	Standard Plastic Cover	Standard Metal Cover
Concealed	Concealed	Concealed	192-262	192-362
	Exposed		192-264	192-364
Key (See Note 1)	Concealed	Exposed	192-269	192-369
	Exposed		192-270	192-370
Key (Night), Exposed (Day) (See Note 1)	Exposed		192-271	192-371

1. Key set point adjustment cover required for all thermostat chassis with optional 1/2" large set point adjustment knobs.
2. To order an optional thermostat cover finish, add the appropriate suffix letter listed in Table 4 to the end of the part number listed in Table 3.

**Table 4. TH 192 DN & DNV Thermostat
Suffix Letters for Optional Cover Part Numbers.**

NOTE: For color samples, order color reference guide 152-178P10.

Part Number Suffix Letter	Cover Material	Cover Finish	Part Number Suffix Letter	Cover Material	Cover Finish
None	Plastic (standard)	Desert Beige	D	Metal (optional)	#10 Special Bronze
W	Plastic (optional)	White	E		Brushed Electro-plated Satin Chrome
None	Metal (standard)	Desert Beige	F		Sierra Gold
A	Metal (optional)	#1 Silver	G		Brushed Aluminum
B		#5 Satin Chrome	H		White
C		#7 Light Statuary Bronze			

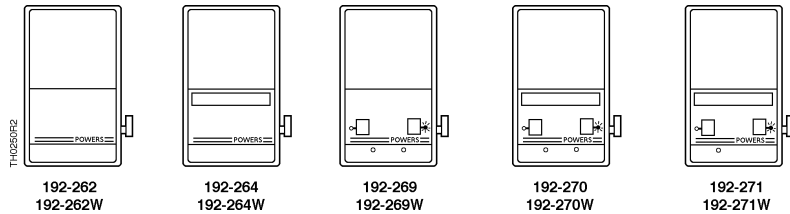

Specifications

Control action	See Table 2.
Operating ranges	45 to 85°F (7 to 30°C)
Supply air pressure, maximum	30 psi (207 kPa)
Normal air supply pressure	
Day	18 psi (124 kPa)
Night	25 psi (172 kPa)
Sensitivity adjustment	1 to 4 psi/°F (12 to 50 kPa/°C)
Nominal air consumption, two-pipe	25 scim (6.8 ml/sec)
Temperature	
Storage temperature	-10 to 140°F (-23 to 60°C)
Ambient operating temperature	40 to 140°F (4 to 60°C)
Temperature response	0.1°F (0.06°C)
Dial graduations	2°F (1°C)
Factory settings	
Calibration @ 72°F (22°C)	7.5 psi (52 kPa)
Sensitivity	2.5 psi/°F (31 kPa/°C)
Limit stop adjustment	45 and 85°F (7° and 30°C)
Standard cover	Cyclac, desert beige
Shipping weight	0.7 lbs. (0.3 kg)
Dimensions	See Figure 4.

Accessories

See the following Technical Bulletins for information on accessories.

Technical Bulletin	Document Number
TB 237 Terminal Kits	155-244
TB 213 Aspirator Wall Box Kit	155-245
TB 214 Adapter Kits	155-231
TB 193 Guard Kit	155-222
TB 241 Test Head Kit	155-255
TB 167 Restrictors	155-213

Dimensions

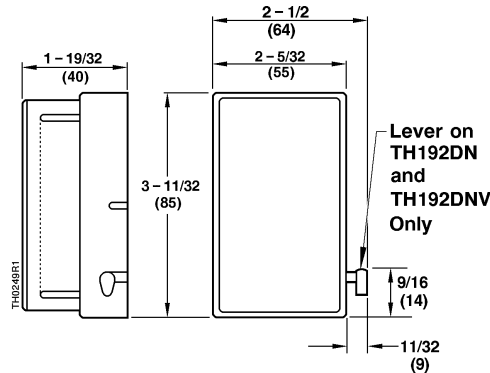

Figure 4. TH 192 DN & DNV Dimensions in Inches (Millimeters).

Operation

Day-Night Operation

The TH 192 DN thermostat is either direct or reverse acting for both day and night operating modes. In a direct acting thermostat, an increase in temperature increases the control air pressure and a decrease in temperature decreases the control pressure. In a reverse acting thermostat, an increase in temperature decreases the control air pressure and a decrease in temperature increases the control pressure.

The TH 192 DN provides two separate bimetal elements; one for day temperature and one for night temperature. Each bimetal element operates independently of the other. Use of two different supply air pressures accomplishes changeover from day to night temperature. A supply pressure of 18 psi (124 kPa) or 25 psi (172 kPa) positions a changeover switch so a changeover relay operates in the day or night mode respectively.

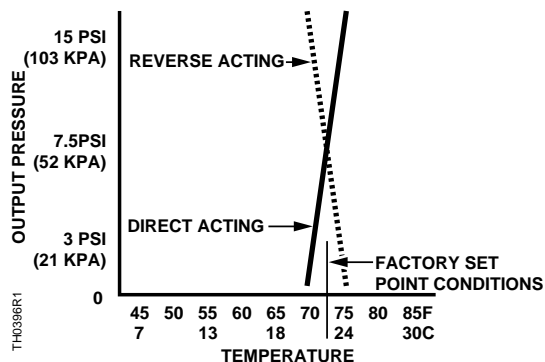

Figure 5. TH 192 DN & DNV Input/Output Characteristics.

- Manual Selector Switch A manual selector switch allows an individual thermostat to control at its day setting even though the remainder of the system is controlling at its night setting.
- In the normal AUTO position, the manual selector switch does not interfere with air passage to the changeover relay.
 - To manually set the selector switch to the DAY position, push selector in until it latches and the handle points downward. In the latched DAY position, the manual selector switch seals off air to the changeover relay.
 - To manually reset the selector switch, rotate the handle until it unlatches and returns to the normal AUTO position.
 - Manual Selector Switch resets automatically when supply pressure changes back to day time control.

Day-Night-Vent Operation The TH 192 DNV provides a supplementary air line connection at the back of the thermostat.

NOTE: This third line feature cannot be added to a TH 192 DN in the field.

The vent line provides either 0 or 25 psi (0 or 172 kPa) pressure via the manual selector switch to pilot auxiliary controls. For example, a unit ventilator can provide continuous full day operation when the space is occupied and intermittent night operation when the space is unoccupied.

TH 192 DN & DNV Thermostat Details

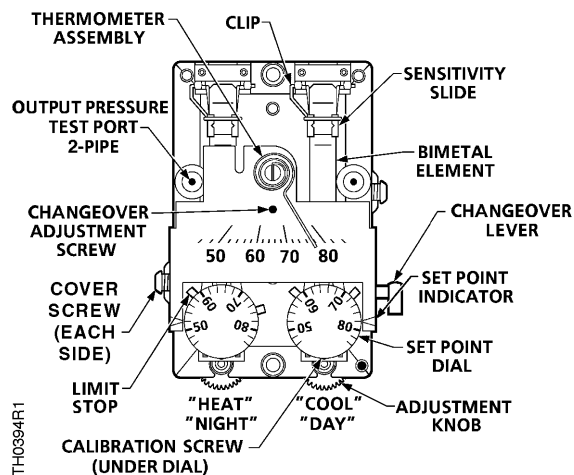

Figure 6. TH 192 DN & DNV Thermostat Details.

Thermometer Calibration

1. Use a test thermometer to read the current room temperature.
2. Place a screwdriver in the center of the thermometer assembly (Figure 6). Carefully rotate thermometer assembly until pointer tip indicates the correct room temperature.

NOTE: Avoid breathing on or touching the bimetal spiral since this influences the temperature reading.

Changeover Point Adjustment

The changeover point is factory set to occur between 19 and 22 psi (131 and 152 kPa). The changeover point can be field adjustable to occur between 14 and 22 psi (96 and 152 kPa).

1. Connect pressure gauge or manometer to measure supply pressure to thermostat. Use 30 psi (207 kPa) supply through a positioning switch so pressure can be fully variable.
2. Determine current change over point. Turn day dial so day and night control pressures are different. Then note the changeover point on the control gauge as the supply pressure changes.
3. Remove thermometer for access to changeover adjust screw. Use a 1/16" Allen Hex Key to adjust changeover adjust screw as follows:
 - a. If changeover is too high, turn off supply pressure and rotate changeover adjust screw clockwise. One turn decreases changeover point by about 3 psi (20 kPa). Turn on supply pressure and recheck to verify new changeover point.
 - b. If changeover is too low, turn off supply pressure and rotate changeover adjust screw counterclockwise. One turn increases changeover point by about 3 psi (20 kPa). Turn on supply pressure and recheck to verify new changeover point.

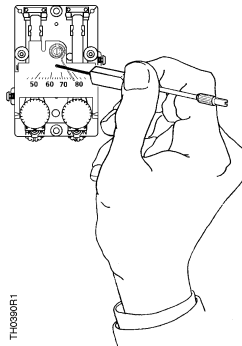

Figure 7. Changeover Point Adjustment.

Limit Stop Adjustment

Thermostat limit stops define the minimum and maximum thermostat set points. The limit stops engage in the set point cam gear teeth and cause interference between the set point cam gear and the adjustment knob gear.

To change limit stop settings, use needle nose pliers to pull limit stop between the set point cam gear teeth. Rotate limit stop to its new position. Do not pull limit stop any more than necessary to clear the gear teeth. Changing the limit stop position one gear tooth changes the limit stop setting by 1-1/3°F (0.7°C).

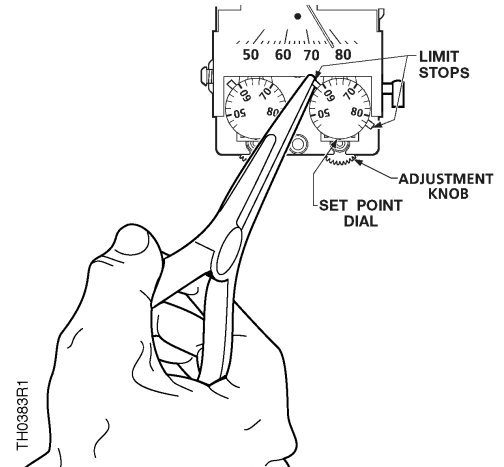

Figure 8. TH 192 DN & DNV Limit Stop Adjustments.

Sensitivity Adjustment

To change thermostat sensitivity, use a flat blade screwdriver to carefully move the sensitivity slide to the desired position as follows:

Graduation closest to the rigid end of the bimetal element
4 psi/°F
(50 kPa/°C)



Graduation closest to the minimum (MIN) end of the bimetal element
1 psi/°F
(12 kPa/°C)

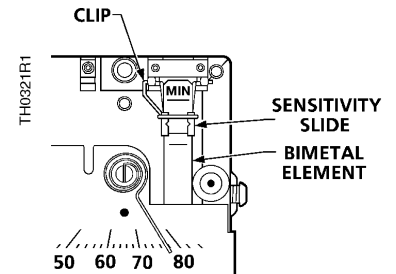

Figure 9. TH 192 DN & DNV Sensitivity Adjustment.

NOTE: If the thermostat sensitivity is adjusted, the thermostat must be recalibrated.

Thermostat Calibration

The thermostat is factory calibrated to a control pressure of 7.5 psi (52 kPa) when the set point and the ambient temperature are both at 72°F (22°C). The factory sensitivity setting is approximately 2.5 psi/°F (31 kPa/°C). No adjustments are required if these settings are appropriate for the application. If the thermostat has been tampered, the sensitivity changed, or is out of adjustment, use the following steps to re-calibrate the instrument.

Day Time Calibration

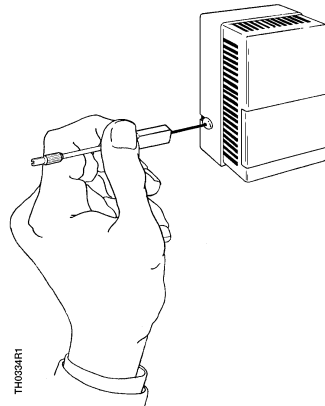

Step 1 —
Remove cover using 192-632 calibration tool. Verify room temperature is between 70 and 80°F (21 and 27°C).

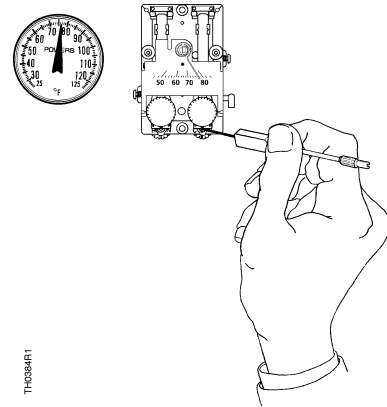

Step 2 —
Verify that supply pressure is 18 psi (124 kPa). Set day time dial to room temperature by turning the exposed adjustment knob or using a hex key as shown. Allow thermostat to stand for about five minutes to adjust to the new setting.

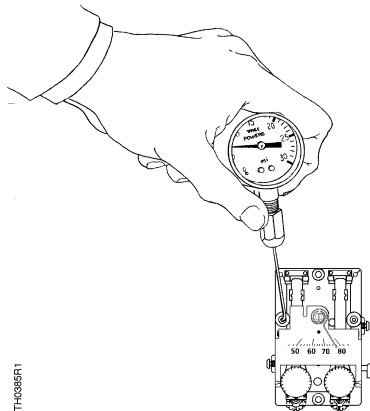

Step 3 —
Moisten needle and insert 192-633 test gauge and needle adapter in the test port. Read control pressure.

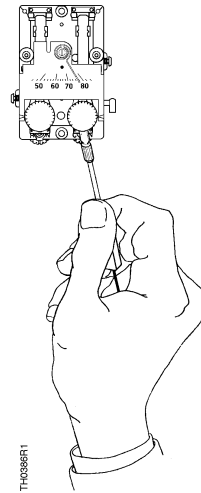

Step 4 —
If control pressure does not read 7 to 8 psi (48 to 55 kPa), turn calibration screw using 192-632 calibration tool or 1/8" (3.2 mm) wrench until pressure is 7 to 8 psi (48 to 55 kPa). The sensing element is now in calibration and the set point can be changed to the desired room temperature.

Night Time Calibration

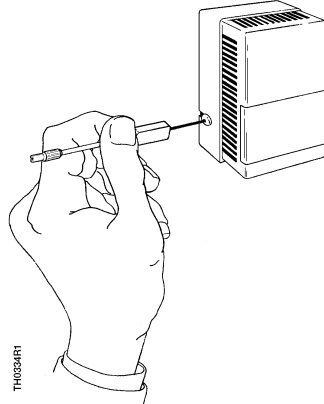

Step 1 —

If not already done, remove cover using 192-632 calibration tool. Verify room temperature is between 70 and 80°F (21 and 27°C).

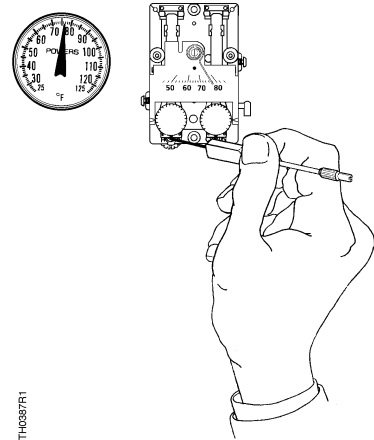

Step 2 —

Verify that supply pressure is 25 psi (172 kPa). Set night time dial to room temperature by turning the exposed adjustment knob or using a hex key as shown. Allow thermostat to stand for about five minutes to adjust to the new setting.

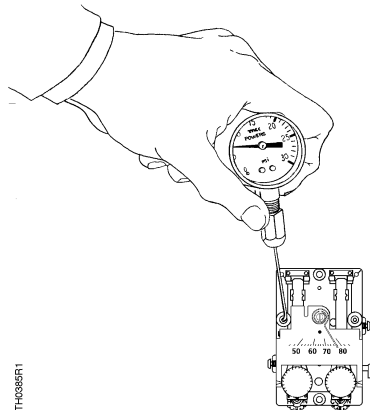

Step 3 —

Moisten needle and insert 192-633 test gauge and needle adapter in the test port. Read control pressure.

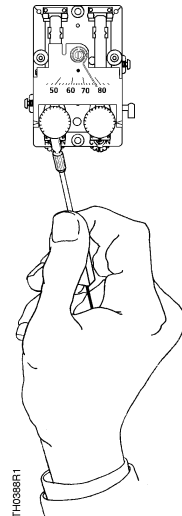

Step 4 —

If control pressure does not read 7 to 8 psi (48 to 55 kPa), turn calibration screw using 192-632 calibration tool or 1/8" (3.2 mm) wrench until pressure is 7 to 8 psi (48 to 55 kPa). The sensing element is now in calibration and the set point can be changed to the desired room temperature.

Troubleshooting

Before troubleshooting thermostat per Table 5, make certain there is clean dry supply air at 18 psi (124 kPa) for day control and 25 psi (172 kPa) for night. Use test probe gauge and needle adapter to measure control pressure at thermostat test port.

The output pressure test port is accessible without removing the thermostat cover through the 8th opening from the top left side.

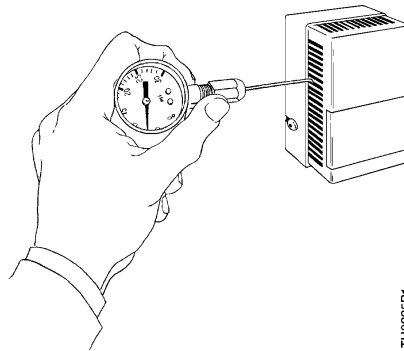

Figure 10. Accessing Output Pressure Test Port.

Table 5. Troubleshooting Guide.

Problem	Check	Cause	Action
Control pressure stays at approximately zero	Air supply	Low supply pressure	As required
	Nozzle or flapper	Dirt on nozzle or flapper	Clean nozzle or replace thermostat
	Restrictor	Clogged restrictor	Replace restrictor
	Calibration	Out of calibration	Recalibrate
Control pressure stays at approximately supply pressure	Nozzle	Clogged nozzle	Clean nozzle or replace thermostat
	Calibration	Dirt on either supply or exhaust valve seat	Alternately close and open nozzle by gently pushing down the bimetal
Excessive air leakage from exhaust port on left side of thermostat	Supply and return line connection	Connections are interchanged or connection to port is incorrect	As required

Chassis Tube Connector and Restrictor Plate Replacement



1. Remove thermostat chassis from wall. Terminal does not have a ball check valve.
- NOTE:** You must close off the supply air. For example, use a connector with the supply air terminal plugged.
2. Remove two Phillips head screws from connector on back of thermostat chassis. Pull connector out of recess. If necessary, pry connector loose with a screw driver, but be careful not to damage restrictor plate and gasket.
 3. Remove gasket from under connector. Remove restrictor. Remove second gasket from under restrictor.
 4. Use restrictor replacement kit 192-321 to replace gasket, restrictor, and second gasket.
- NOTE:** The restrictor plate is keyed to ensure proper orientation during installation.
5. Remove filters from existing connector and insert in new connector. Or, if filters are dirty, use restrictor replacement kit 192-321 to replace filters.
 6. Use chassis tube connector replacement kit 192-525 to replace connector and mounting screws.

Service Parts

The following chart lists accessory parts and tools available for thermostat service.

Description	Part Number
Dial thermometer (-40 to 140°F, -40 to 60°C) with pocket case	141-0573
Basic pneumatic calibration kit with thermometer, gauge, squeeze bulb, fittings, and case	832-177
Test head kit	832-179
Calibration tools	832-178
Test probe to check pressure with cover on	
Needle probe with 1-1/2" diameter gauge 0-30 psig (0-200 kPa) and calibration/cover wrench	192-633
Needle probe, no gauge (package of five)	192-759
1-1/2" diameter gauge, 0-200 kPa, back connected 1/8" NPT male	142-0344
1-1/2" diameter compound gauge, 0-30 psig/0-200 kPa, back connected 1/8" NPT male	142-0373
1-1/2" diameter compound gauge, 0-30 psig/0-200 kPa, bottom connected 1/8" NPT male. Replacement for use with 192-633	142-0426
Chassis tube connector replacement kit with mounting screws (material for 10 thermostats included)	192-525
Restrictor plate replacement kit with filters and gasket (material for 10 thermostats included)	192-321

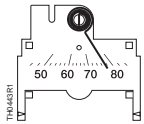
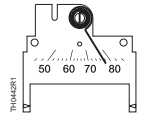
**Service Parts
 (Continued)**

Description		Part Numbers	
Plug-in adapters for quick thermostat removal			
Straight, blue (package of 20)		192-485	
Straight, white (package of 20)		192-486	
Air link connects adapters for pressure tests (package of 20)		192-501	
Compression ring (package of 100)		141-388	
Elbow (provides quick return for wall surface mounting), blue (package of 20)		192-487	
Elbow (provides quick return for wall surface mounting), white (package of 20)		192-488	
20 scim (5.4 ml/sec) restrictors for 1-pipe systems (package of 5). (1/4", 6.4 mm, OD plastic barb unless noted.)			
Brass coupling, 1/8" NPT (1 only).		184-040	
Coupling		184-116	
Tee		184-113	
Pre-piped dual tee for dual 1-pipe systems		184-130	
Replacement thermometer kits, brown (packages of 5)			
Scale Range	Thermostat Model		
45° to 85°F		192-775	
10° to 30°C	Model 3 and Up	192-776	
45° to 85°F		192-786	
10° to 30°C	Models 1 and 2	192-785	
Replacement set point dials (packages of 10)			
°F, Direct Acting	Right Side		192-779
°F, Reverse Acting			192-780
°C, Direct Acting			192-783
°C, Reverse Acting			192-784
°F, Direct Acting	Left Side		192-777
°F, Reverse Acting			192-778
°C, Direct Acting			192-781
°C, Reverse Acting			192-782

Information in this publication is based on current specifications. The company reserves the right to make changes in specifications and models as design improvements are introduced. © 1999 Siemens Corporation